

# *OKAYO*

## AUDIO GUIDE

### AT-100



[USER MANUAL]

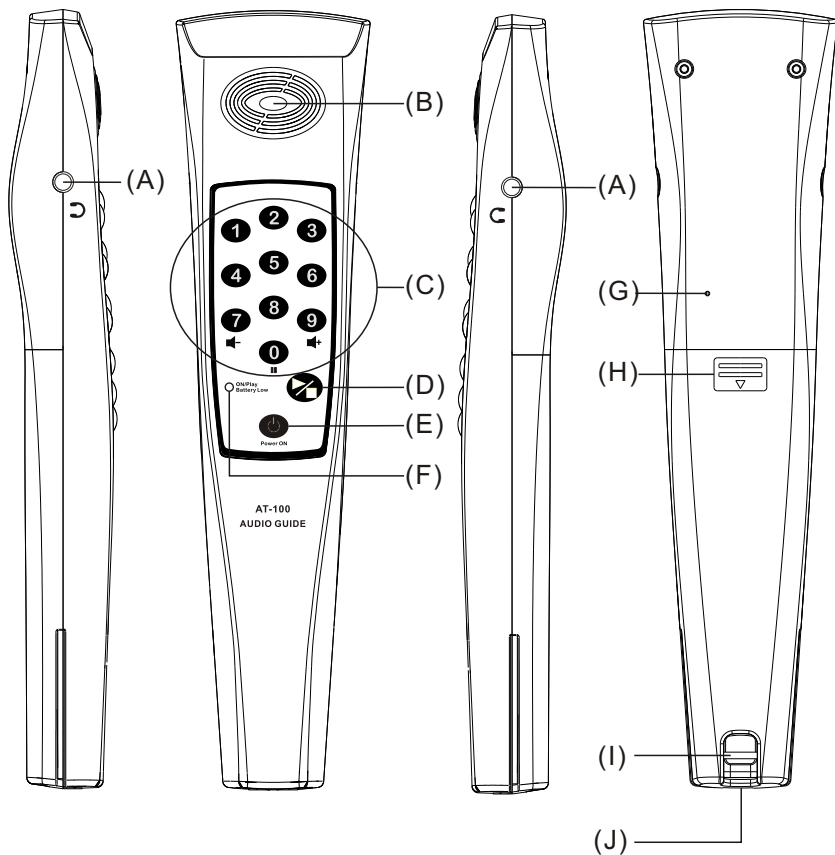

**(A) Earphone jack:**

Earphone jack (stereo) x 2.

**(B) Loudspeaker:**

An alternative for individual preference in listening.  
Loudspeaker will not work when an earphone is used.

**(C) Numeric keypad 0~9:**

Act as message code, volume adjustment and pause.

**(D) Play/Stop:**

To play or stop a selected message.

**(E) Power on/power off:**

Press the button to power on; press and hold 2 seconds to power off.

**(F) LED indicator:**

Green LED-power on (stand-by); Amber LED-power insufficient ; Red LED glittering-running out of power.

**(G) Hole on rear casing:**

Unlock battery door by inserting a pin in the hole on rear casing.

**(H) Battery door:**

Insert a pin ( $\phi$  1.0 mm) in the hole on rear casing and slide it to change batteries.

**(I) Lanyard loop:**

Used with lanyard N-30 as a solution for hand-free.

**(J) IEEE 1394 port:**

Act as a port to connect with Audio Guide Updater ATC-110U.

## **PREFACE:**

Thank you for the purchase of this Audio Guide AT-100. This user manual offers comprehensive operation of the unit. Please read it over before your use.

This unit can work with Audio Guide Charger ATC-110 or Audio Guide Updater ATC-110U for better performance. Please refer to ATC-110 and ATC-110U user manual for more information.

## INDEX:

### AT-100 AUDIO GUIDE

|                                |     |
|--------------------------------|-----|
| Illustration.....              | 1~2 |
| How to use.....                | 3~4 |
| Caution / Troubleshooting..... | 5   |
| Features / Specifications..... | 6   |

# ILLUSTRATION

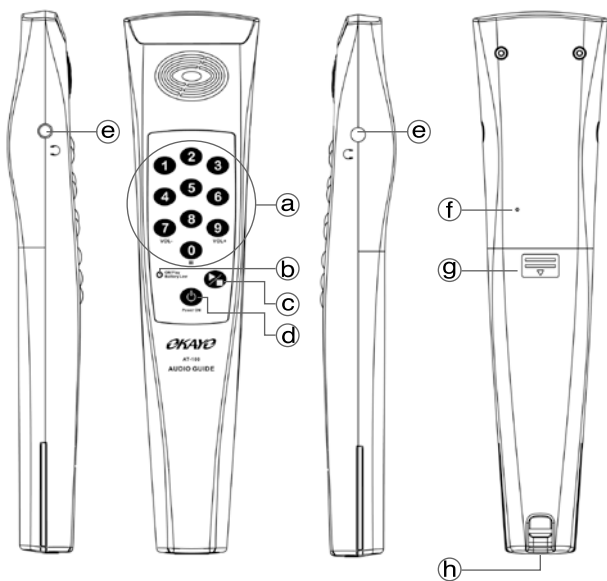

## ILLUSTRATION

Ⓐ **Numeric keypad (0~9):** Press required numbers through numeric keypad to listen. Number "0", "7" and "9" offer special functions described as below.

A. 「0」 : Pause/Resume.

B. 「7」 : Volume down.

C. 「9」 : Volume up.

Ⓑ **LED indicator:**

A. Indicator lights greenly: Device is working under good condition.

B. Indicator lights amber: Battery energy is not sufficient.

C. Indicator glitters redly: Device is running out of power.

Ⓒ **Play/Stop:** To play or to stop. Also work as a button to change language folder.

Ⓓ **Power on:** Turn on the unit by pressing it until LED indicator lights greenly. Turn off the unit by pressing it up to 2 sec and LED indicator goes out.

Ⓔ **Stereo output:** 2 output jacks available for earphone.

Ⓕ **Hole to unlock battery cover:**  
To open the battery door, please insert a needle (Ø10mm) into the hole and push battery door forward at the same time.



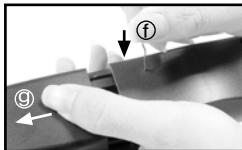

Ⓖ **Battery door.**

Ⓗ **Loop for neck cord.**





## HOW TO USE

### A. General operation: (for general users.)

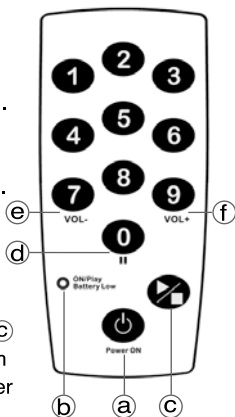



1. Insert batteries correctly. Batteries could be 2 AA rechargeable NIMH batteries 1.2 V (1600 mAh or above is recommended), or 2 AA Alkaline batteries 1.5 V. Do not mix batteries to use.
2. Turn on the device by pressing  (a) until LED indicator (b) lights greenly.
3. If you want to play 4<sup>th</sup> file under a selected language folder, simply press POWER ON  (a) and press numeric 4 after indicator lights greenly then press PLAY/STOP  (c). The indicator (b) will glitter greenly while playing selected file. When play is finished, the indicator will become green and keep on.
4. If you want to PAUSE the play of 4<sup>th</sup> file simply press numeric 0 (|| (d)), the indicator will glitter slowly.
5. Press numeric 0 (|| (d)) or PLAY/STOP  (c) to keep on playing. The file starts to play from where just paused and the indicator will glitter fast.)
6. Adjust the volume level by pressing numeric 9 (up) VOL+ (f) or numeric 7 (down) VOL- (e). Totally 10 levels are available. Every press on numeric 9 VOL+ (f) . or numeric 7 VOL- (e) will get a respective volume up or down. Factory preset of volume is fixed at 6<sup>th</sup> level.



## HOW TO USE

7. Volume adjustment (numeric 9 & 7) can't be in function when PAUSE or STOP playing the file.
8. When the file is on play, press PLAY/STOP  (c) to stop. When a file is on play, must press PLAY/STOP  before entering a desired file number.
9. AT-100 will turn off ( LED  (b) off) automatically when there isn't any action made to the unit under standby mode for certain of period. (please refer to ATC-110U user manual for further setup.)

### **B. Advanced operation: (for system maintainers or service providers)**

1. Please change batteries (Alkaline) or put AT-100 onto compatible charger (ATC-110/ATC-110U) when pressing POWER ON  (a) and the LED indicator  (b) shows redly.
2. Change language folder: Totally 32 language folders are available, number code given from 951 to 982.
3. How to change to desired language folder: Enter desired language folder code under standby mode (LED indicator lights greenly); and press PLAY/STOP  (c) to implement. For example, if language folder code 951 is the desired one to change from current language folder, simply enter numeric 9, 5, 1 and press PLAY/STOP  (c) to implement under standby mode. The indicator will glitter twice at the same time, and it means this change is successful.
4. How to update data: Please refer to Audio Guide Updater ATC-110U for more information.

## CAUTION / TROUBLESHOOTING

### Caution:

1. Keep away from heating source; don't put the unit next to any object with high heat or temperature.
2. Inappropriate move or squeeze is prohibited.
3. DO NOT use rechargeable and general batteries together. DO NOT mix old and new batteries to charge.
4. Please take out batteries if the units won't be in use for a longer period in case of any leakage from batteries.

### Troubleshooting:

1. Fail to turn on: Make sure batteries were inserted correctly. Make sure batteries are in good conditions.
2. Numeric keypad fail to react: Make sure the selected folder or file exists or not.
3. AT-100 will fail to play when changed to a new language folder which is empty in content and has no greeting edited. Please update AT-100 through computer.
4. When entered a number code in a language folder but it failed to react: Make sure the file(s) exists or not.
5. LED indicator lights redly when turn on: Batteries are running out of energy. Please change with new batteries or charge batteries (NiMH rechargeable only).

## FEATURES / SPECIFICATIONS

### FEATURES

1. User friendly.
2. Built-in speaker.
3. 2 stereo output available for earphone.
4. Offer up to 32 language folders to edit.
5. Quality sound rivals to CD.

### Audio parameters

|                    |                                   |
|--------------------|-----------------------------------|
| Frequency response | 50 Hz ~ 18 kHz                    |
| Dynamic range      | 95 dB                             |
| T.H.D.             | < 0.1 %                           |
| Built-in speaker   | 0.2 W @ 8 $\Omega$                |
| Audio output       | 3.5 mm earphone jack (stereo) x 2 |

### General parameters

|                               |  |
|-------------------------------|--|
| Recording time capacity (1GB) | 1,024 minutes (stereo) or 2,048 minutes (mono) @ 44.1 kHz sampling, 128 kbps bit-rate        |
| Available language folders    | 32 (max.)  |
| Available files to edit       | 950 (max.)   |
| Storage medium                | SD memory stick  |
| Optional SD memory stick      | 1 GB / 2 GB  |
| File format                   | FAT-12 / FAT-16 / FAT-32   |
| Controlled keypad             | 12 buttons available   |
| Indicator                     | Power on (LED lights greenly), Playing (LED flashes greenly), Battery low (LED lights redly) |
| Ambient temperature           | -10 ~ 50 °C  |
| Power supply                  | 2 x AA 1.2 V (NiMH, 1600 mAh) rechargeable / 2 x AA 1.5 V alkaline                           |
| Battery autonomy              | 10 hours (rechargeable) / 16 hours (alkaline)  |
| Static current consumption    | < 10 $\mu$ A   |
| Current consumption           | 100 mA (standby) / 160 mA (playing)  |
| Size                          | D 28 x W 59 x H 235 (mm)   |
| Weight                        | 180 g (batteries included)   |

# MEMO

# MEMO

***OKAYO***

Sound & Communication

**E-J ELECTRONICS CO., LTD.**

4F, No.11, Lane 125, Sec 1, Kuo Kwang Rd., Ta Li City,  
Taichung Hsien, Taiwan

**Tel:+886-4-2407-1617 Fax:+886-4-2407-1609**

E-mail:[okayo@okayo.com](mailto:okayo@okayo.com)

[www.okayo.com](http://www.okayo.com)